



11.18.2024

2025 LATE MODEL DIVISION RULES

(Modifications and additions are indicated in **Red** – if rules are printed in color)

1. **FRAMES, CHASSIS, and CAGES**

- A. All cars will have minimum 104.5" and maximum 105.5" wheelbase, measured from center of lower ball joint to center of rear end, with a maximum tread width of 64.5".

- Tread width to be measured with ACT tread width gauge.
- Tubular frames on all models, main frame rail members shall have a minimum of:

10" perimeter tubing - .120 wall thickness – measured 2x3x2x3

12" perimeter tubing - .095 wall thickness – measured 3x3x3x3

16" perimeter tubing - .083 wall thickness – measured 4x4x4x4

NO NOTCHING or CUT OUTS ALLOWED for suspension travel

- Sections extending, such as front and rear clips, must be a minimum of 10 inches in perimeter and have a minimum of .083" wall thickness and extend 10 inches minimum beyond wheelbase.
- Rear clip must extend beyond fuel cell area.
- **Chevrolet V-8 engines only** and must be placed with center of number one spark plug or center of hex if angle fitted even with center of grease fittings on upper ball joints.
- **"OPTIONAL" - All GM Engines will be allowed a 2" engine setback.**
- Ford engine will be measured from front of right head to center of right front ball joint. (This will result in 1-7/8ths inch setback compared to Chevrolet.)
- **Centerline of engine must remain within 1/2" (1/2 inch) measurement of centerline of tread width, measured from the inner pivot point of equal length front lower control arms on both sides of snout. A-frame suspensions will be measured from lower ball joints.**
- ACT perimeter chassis, by definition, must maintain equal lower control arm measurements.
- Material to be used must be DOM or seamless, .090 minimum wall steel tubing.
- Maintain integrity of tubing and wall thickness throughout the construction of Frames, Chassis, and Cage.
- All cars required to have a 4-point or main structure of the roll cage and must be symmetrical in all directions, (See roll cage section Page 2 - B - #5).
- Minimum 1-1/2" diameter tubing inside driver's compartment.
- Four curved horizontal door bars on driver's side.
- Minimum height of door bars 22-1/2 inches from bottom of frame.
- Passenger side three curved door bars with minimum 66 inches between driver's side door bars and passenger side door bars, outside to outside, **or** an "X" bar with approved side body panel supports.
- A so-called "Petty Bar" must run from center of cage to upper right front halo.
 - > **Main frame rails and clips may not be pierced or drilled or otherwise altered for purpose of reducing weight.**
 - > **All lead must be painted white, with car # painted in contrasting color.**
 - > **Bolts must pass through lead and must be secured with proper sized bolt and nut. No pinch bolts allowed.**

B. **Specifications for Perimeter Chassis and Roll Cage**

1. **NO OFFSET CHASSIS ALLOWED, UNLESS SPECIFIED IN RULES.**

2. **Center Section Frame Rails:** Measured from inside to inside at MINIMUM 52 inches with 1/4 inch tolerance.

3. **Offset**

-Maximum offset allowed 1" from center line measured 1/2" from center line equally side to

side with a total of 1" maximum offset. Center line determined by using center section measurement (see page 1-B-#2).

4. Roll cage/Halo

-Roll cage structure will be made of 1 ¾ O.D. inch tubing with .090 minimum wall steel tubing.

-Additional components within the center roll cage section must be minimum 1½ inch diameter tubing and minimum .065 wall steel tubing

-Integrity of the roll cage must be maintained

-Height of roll cage total symmetry to be no less than 40"

-Total height of Halo to be no less than 1" lower than cage

-Width of Halo measurement minimum 44" measured from outside to outside tubing

-Rear roll cage posts must be attached to frame rails in a direct diagonal straight line from the firewall (see diagram for further clarification -page 15)

5. The center of fuel cell must be within ½" of centerline measurement of center section

- C. 18" gauge steel minimum, 18 inches high foot firewall. Top of foot box must be 18" gauge steel. 9-inch-high driver's tunnel and 18 inches high behind seat.

A "Red Mead" bar or 1/8" minimum steel plate is mandatory under driver's seat (see diagram Page 15)
A foot safety bar is mandatory. A support for headrest or seat back extending to support back of head is mandatory.

- D. No cluster type digital dashes allowed. NO acquisition/computer data allowed of any kind.

2. INTERIOR DETAIL

- A. A full width dash is required in all cars. Vertical surface of dash must project in a single plane across the car. Top horizontal plane of the dash should carry forward to the firewall and enclose entire area beneath windshield. Instruments must be neatly mounted to vertical plane of dash panel.
- B. Interior of car must be completely enclosed with respect to engine compartment, track surface, tires and rear fuel cell compartment. Interior panels must be minimum of .040-inch thickness of aluminum or steel.
- C. Only one rear view mirror inside car approved. A left side exterior mirror is approved but cannot extend outside of the windshield "A" pillar.
- D. No rub rails allowed outside car.

3. ELIGIBLE BODIES - See diagram – Page 16 for measurements

- A. **Bodies**
- Bodies must be aftermarket made of plastic or aluminum with rubber front and rear bumpers, fiberglass hoods and window frames.
 - ACT approved bodies only. NO CARBON FIBER BODYPANELS.
 - **Bodies must meet tech visual approval – weight penalties may be imposed at tech director's discretion for violations. No mixing and matching of manufacturer body panels.**

B. ABC bodies are required. Fiberglass quarter panels will be allowed. "Rubber" quarter panels may be used upon availability. All ABC bodies must meet manufacturer's "Referee" technical inspection and be mounted as "**OUT OF BOX**". *½" tolerance of any measurement with templates will be allowed. Front and rear bumper covers must be mounted center to centerline of chassis.*

C. **THE GEN 6 LATE MODEL BODY AND AR BODIES EVOLUTION RE-SKIN KIT AND BODY ARE ALLOWED FOR ACT COMPETITION. MUST FIT TEMPLATES AT ALL TIMES.**

All Ford engine cars must run an approved Ford Body (for tour cars only) for FORD contingency money.

Any variations need tech approval and may carry penalties.

- Plastic roof panels are optional.
- MAX Body width at widest point 79 ½ inches.

E. **All body panels must be complete in length and width: Absolutely no cutting or altering door, fender, roof or quarter panels. A-Post, door and fender should meet as shown in diagrams on pg. 15.** Overall workmanship shall be a determining factor as to whether a car shall be approved for competition. Specified components' compliance to templates and overall level of workmanship and appearance will be considered by technical inspectors.
(See diagrams – Pages 15-18 for body measurements).

F. No bumper tubing or bracing allowed lower than front or rear bumper covers.

G. **ABC body measurements must be strictly adhered to – templates will be used to measure from front windshield to rear spoiler, and from right quarter panel to left quarter panel, with ½" tolerance, when determined by ACT officials.**

H. ABC noses are required to have a minimum measurement of 20" from bottom of valance to hood depression measured at center of nose.

I. NO panning under car allowed! Complete discretion of tech officials.
Any quote/unquoted pan/lead tray larger than 7" x 14" MUST have holes no smaller than 3" diameter and spaced 6" on center from each other.

J. **AR Revolution (Rev) bodies**

All AR Rev bodies must use 4 1/2" height and 58" long rear spoiler, mounted in center of body.

4. SPOILERS

A. **ALL REAR SPOILERS MUST BE MADE OF LEXAN AND MUST REMAIN CLEAR**, maximum width of 60 inches wide and 5 inches high. All heights reference to ABC body dimensions. No side enclosure, no lips or bends in upper portion of spoiler and must be flush to vertical surfaces of deck lid **and must be mounted center of rear bumper cover.**

B. ABC spoiler heights will be according to instruction manual and will be subject to approved inspections. Measurement will be from top flat surface at the end of trunk lid to ground at 34-7/8". See spoiler section above for approved spoiler size, (60 inches wide and 5 inches high).

C. **All spoiler MUST have a minimum of FOUR external spoiler braces, two for each half. Braces MUST be BOLTED on each end, NO pop rivets.**

5. EXHAUST/HEADERS

A. Exhaust

- **Absolutely no sensors in any part of exhaust system.**

- Absolutely no additional holes, vents, etc., may be added to body components outside stock configuration.
- Exhaust holes may be cut.
- Recommended that exhaust exit under car or may exit outside of car. If exhaust exits under Car it must point toward racetrack and maintain 4" ground clearance.
- Exhaust must exit in duals.
- Two *unaltered Magnaflow #11219* mufflers required.
- Steel pipe must be used to extend beyond driver seat and may not be cut or modified and **MUST** be installed in correct flow direction and used in its entirety.
- Exhaust pipe exit maximum size 3-1/2 inches.
- No scavenger systems.
- MAGNAFLOW Muffler Part #11219 **MUST** be used.
- Weekly or touring competitors must be in compliance with track and/or local ordinance rules.

B. Headers allowed. No 180-degree headers allowed. All 4 tubes from right and left banks of engine must enter single collector on each respective side of exhaust. No balance tubes or any crossover type exhaust systems allowed. Must be made of mild steel, no stainless.

6. WINDOWS

A. A full stock dimension windshield is mandatory and must be constructed of 1/8th inch minimum thickness lexan. Three internal windshield braces spaced at least on 5-inch centers and roughly centered upon windshield constructed of minimum 1 inch wide by 1/8-inch-thick material are mandatory.

B. Models with rear quarter windows may have stock openings covered with securely mounted solid, clear lexan. Rear side window may have approved air vents for driver. "A" pillar windows not to exceed **12"** in any direction measured from front of door opening. No interior air deflectors allowed.

C. A full dimension rear glass constructed of minimum 1/8th inch thick **clear** lexan is mandatory and must be held securely in place. **Back window must be securely braced internally to prevent significant bowing or distortion at racing speed.**

7. NUMBERS

A. A quality paint job is mandatory on all cars with **high contrast** numbers for legibility day or night. Bodies must always be kept neat and painted. No metallic numbers.

B. A minimum 24-inch high, 3-inch stroke number is required on the door area on both sides of car. A minimum of 30-inch high, 3-inch stroke number is required on top of roof facing the passenger side of car. A block style number is **REQUIRED** on right (passenger side) front windshield. All numbers must be ACT registered and/or assigned. Number alterations may be required at any time by ACT to avoid duplication.

C. ***All registered and /or assigned numbers MUST also have their registered STATE abbreviation on both doors and roof of car. The state abbreviation needs to be 4 1/2 - 5 inches in size and placed after the number (not inside the number).***

8. CHASSIS/BODY HEIGHTS

A. Minimum ground clearance of any component is **"4 INCHES"**, with driver in car.

9. WEIGHTS

A. Weight: **2800 lbs. (All ACT legal cars)**
(Weights subject to change in the interest of parity)

- All cars will be weighed with drivers.
- **Cars must have a maximum 57.0% of total weight on left side.**
- All heights will be measured with driver in car, including after heats and features unless otherwise notified.

- B. Cars must weigh approved weights after all qualifying heats. Cars must weigh **minimum** 2800 lbs. at start of all qualifying and feature events. **After qualifying, all weights must be minimum 2800 lbs.**
- C. The following allowances will apply in postrace tech inspections:
- | | | |
|-------------------|---------------------------|--|
| Scheduled: | 50 lap events: | 35 lbs. tolerance |
| | 100 lap events: | 75 lbs. tolerance |
| | 101–200 lap event: | 100 lbs. tolerance if fuel stop is required |

Post race fuel weights may be adjusted, if necessary, with notification at driver's meeting.

D. Ballast weight must be securely attached to main frame rail or major cross member structure. Ballast is not allowed to be mounted beyond centerline of wheelbase. No tungsten, lead shot, ball bearing type, or liquid type ballast permitted. No moving weight allowed. Additional brackets or weight holders beyond main frame rails must be approved by technical committee and may require modification or elimination upon inspection. Any questions can be addressed at practice sessions prior to season opening events.

10. ENGINES

APPROVED ACT ENGINE BUILDERS

RPM RACING ENGINES LLC
802-524-7406

LARRY'S AUTO MACHINE
860-449-9112

NAT'S RACING ENGINES
508-336-4142

HULL MOTORSPORTS
802-479-4579

MAC ROD SHOP LLC **PRO-MOTEUR**
418-389-4572 450-759-5362

NOVA MOTORSPORTS
248-767-9560

DRIVR PERFORMANCE
844-475-6888

ENGINE BUILDERS MUST USE ACT PROCEDURES AND SEALS.

- A. Certain individual track rules (including motors) may be subject to ACT inspection, procedures, weight penalties, restrictor plates, and any other modifications ACT deems necessary in the interest of competition.
- B. #GM 88958603 or **19318604 ACT sealed motor only.**
- C. **ALL MOTORS MUST BE REGISTERED EACH YEAR WITH THE ACT OFFICE.**
- D. Roller rocker arms are approved **for GM 603 engine option only.** ONLY GM part number **19210724** OR GM set number **19210728** PR Scorpion part number 1035BL are approved. These are 1.5 ratio rocker arms.
- E. **FORD MOTOR:**
- ACT approved **M-6007-S347JR** Ford motor only. **Must meet all specs as determined by ACT.**
 - Only Ford spec motors which are ACT approved will be allowed to compete in ACT-sanctioned events.
 - Rear starters are allowed on Ford engines ONLY. FORD Quarter Master clutch #298308 with attaching ring gear #110010**
- F. **GM PERFORMANCE SEALED 602 MOTOR:**
- Any use of HEI distributor must run an external rev limiter. 6200 chip Mandatory.**

2. THE 602 LMS MOTOR WILL NOT BE ALLOWED TO BE REBUILT OR REFRESHED.

G. Engine Options

- **FORD 347JR**
 - M-6007 / W4412 Holley 500 CFM with HVH #334412-2AL and Max 6300 Chip
- **GM 602**
 - Bottlecap (Non-Rebuildable) with #80541 650 CFM Holley and Max 6300 Chip
- **GM 603**
 - 4412 Holley 500 CFM and HVH #334412-2AL Spacer and Max 6300 Chip
 - 80541 Series Holley 650 CFM and Open Center Spacer (See pg. 7, #12) with ACT Restrictor Plate with Max 6300 Chip
- **GM 604**
 - 4412 Holley 500 CFM and RPM 1445 Restrictor/Spacer and Max 6300 Chip
 - ACT Bottlecap Option – *Must be purchased through ACT Office - 80541 Series 650 CFM with Open Center Spacer, ACT Restrictor Plate and 6300 Chip*

ACT Restrictor Plate To Be Announced in March 2025

H. “OPTIONAL”

All GM Engines will be allowed a “2” engine setback

11. IGNITION

A. 6200 RPM MAXIMUM recommended for Chevrolet engines, **but will be restricted to a maximum 6300 chip, and may be required at certain tracks. Fords will be allowed to run a maximum 6300 chip at all events.** The chip rule may be amended for certain tracks, and teams will be notified in the entry form. The chip rule may be amended in the interest of competition at any time.

B. JMS Ignition System is MANDATORY for all Full-Time, 100% ACT Tour Teams

- JMS Part #6000 6701K ‘JMS CD-1 Race Ignition’.
- No Altering, easy mounting to be swapped out at inspector’s discretion.
- JMS Wiring Harness Highly Suggested.

C. MSD distributor IS allowed. Must contain light blue springs and blue advance stop. Spring and stop part number 8464, distributor numbers MSD 85551, 8570, 85561 or GM part # 10093387 are only approved parts. No tampering or changing of advancement weights or springs allowed in HEI spec motor distributor.

- MSD must use external coil.
- Ends must be original factory MSD or weather pack connectors installed by MSD.
- It is the responsibility of the competitor to configure harnesses to allow the ACT MSD to connect.
- **Ignition Box must be located on the right side of dash panel as far from driver as possible, and out of reach.**
- All wires must be wrapped in a loom material and must pass through firewall at first option. Rivets to hold bottom panel must be drilled out.
- Only one ignition box allowed. ***Any altering of ignition box will result in disqualification and possible suspension.***
- ***Any HEI distributor must run an external rev limit.***
- ***The Ford M.6007.S347JR will be allowed to run the MSD8582 or 8579 distributor.***

12. SPACERS

- Following **carburetor** spacers are allowed **for GM 603 with 4412 Carburetor:**

Canton #85060
Moroso #64964 (aluminum)

- HVH #SS4412-2AL is approved for GM 603 engine and S347JR Ford engine.
- Any teams using the "604" with 4412 Carburetor MUST use "RPM 1445" Restrictor/Spacer.

• GM 603 and 604 with 80541 Series 650cfm Holley Carburetor will be allowed to run ANY straight flute, open centered spacer minimum 3/8" tall to maximum 1" tall.

13. HEIGHTS

- Four (4) inch frame height measured at the lowest point including cross members.
- 47-inch roof height measured 10 inches back from windshield to ground or ABC body must meet Referee standard.
- 11-inch engine height measured from center of crank front to ground.
- Skid plate is mandatory if oil pan is below cross member.
- **Fuel cells must be a minimum height of 8 inches from ground.**

NOTE: (All heights measured with driver (no substitutes) in car and all measurements are official with ACT gauges ONLY.)

14. CARBURETOR, FUEL and FUEL SYSTEMS

- A. A stock 4412 Holley 500 CFM carburetor only is allowed for the GM 604 motor and FORD motor. Absolutely no material may be added or removed from carb, except bolt-on choke mechanism only may be removed. Air filter housing and fresh air box only. **Fuel must not mix with water or any additives.**

FUEL

- A. Fuel cells mandatory and must be approved by technical inspector. Minimum 15-gallon capacity and maximum 22-gallon fuel cell only. It is mandatory that the fuel cell be enclosed in a 20-gauge welded steel box, with a bolt-on cover constructed of twenty-gauge steel and must be protected in back and on sides by .095 1-3/4" O.D. tubing. Fuel cell will be no less than 14 inches from centerline of rear axles to front of fuel cell.
- B. Sunoco Race Fuel is the "Official Fuel" and New England Racing Fuel Inc. is the approved "fuel supplier" for the ACT.
- C. Sunoco Standard Purple 110 Leaded is the ONLY fuel allowed
- D. ACT has the right to sample a competitor's fuel at any time during the event.
- E. Fuel samples may be impounded for testing to the manufacturer's specification.
- F. Any blending and/or mixing of fuels either of or not of the approved fuels is not permitted.
- G. No MTBE, ethers, alcohols, ethanol's, nitrogen, nitro compounds, performance additives or any other oxygenates may be blended/mixed or introduced into the fuel supply either at the fuel cell or upstream in the fuel system.
- H. Thunder Road and WMMP Late Model teams must run Sunoco OR non-ethanol pump gas
- I. Any fuel line passing through interior must be inside of steel tubing.
- J. Check valve vent is required on all fuel cells with hose exiting out of the tail through a spring damper overflow check valve. Securely fastened to the chassis, not to the tail. **NO ZIP-TIES.**
- K. No "**QUICK FILL**" fuel mounting allowed. Outside fuel fill *optional* with cam type fuel cap.
- L. Fuel pump must be mechanical- no electric fuel pumps. Optional - **AN inline fuel pressure regulator will be allowed; Holley part number 12-803 "ONLY"**. An "OBERG SV0828" of SRI Performance #FPF. FSV fuel line safety check valve anti-siphon is MANDATORY mounted at the outlet of the fuel cell.

NOTE All competitors must prominently display a Sunoco Racing Fuel Patch on driving suit and display Sunoco Racing Fuel contingency decal on both sides of the car in a location specified by ACT series. No other racing fuel company decals can be displayed on the car or driver's suit.

15. STEERING

- A. Any type of front steering allowed. Steering box or rack and pinion are allowed.
- B. Power steering pumps must be driven from the front of motor by belts. Steering columns must have minimum of two U-joints.

16. SUSPENSION

NO TITANIUM PARTS OF ANY KIND ARE ALLOWED IN ACT RACING.

- A. Any spindle made of steel. Removable steering arms must be made of steel. Spindles must be same offset left to right.
- B. Any stock or aftermarket upper and lower control arms allowed. Lower control arms must be same length left and right. Heim joints are allowed. Measurement will be from center of mounting point to center **grease fitting**. Jacking bolts allowed. **Must use** only one shock per wheel. **Must use** only one spring per wheel. NO double springs allowed. No devices to limit or stop suspension travel allowed.
- C. All springs must be made of steel—magnet must stick to spring. Coil-overs permitted. **If running coil- over all parts must be same left to right and front to rear.** Spring rubbers will be allowed, must be wired in place. **Maximum of 1 spring rubber in any spring and must be approved in size and shape by ACT. Aluminum, steel, or additives are not allowed in spring rubbers and will not be allowed to overlap itself.**
- D. **NO SUSPENSION TRAVEL LIMITING DEVICES ALLOWED UNLESS SPECIFICALLY OUTLINED IN THE ACT RULEBOOK.** (Examples include, but are not limited to bump stops, coil binding, chains, or shock mounting locations).
- E.
 - i. Front of car will be inspected with driver in car on ¾ inch boards and pushing down until nose is on the ground by crew members.
 - ii. Rear of car will be inspected with driver in car by measuring rear spring then compressing 2 1/2 inches.
 - iii. **ABSOLUTELY NO COILS** will be allowed to touch each other in front or rear of car or any other travel limiting per the discretion of Tech Official if it is legal.
- H. Cars will be inspected by being pushed *down and held down* by crewmembers and will be at the discretion of Tech Officials whether it is legal.
- I. Bumper must be mounted SOLID. No hinges or slides – must always comply with nose height rule.
- J. The intent of this rule does just one thing...it eliminates "bumping" for cars that compete in ACT sanctioned events.

VISUAL INSPECTION BY OFFICIALS TO MEET THE "NO BUMPING ALLOWED" RULE WILL BE UP TO CHIEF TECH INSPECTOR AND CONSIDERED FINAL.

- G. NO pre-loaders of any type allowed.
- H. NO Coil-over Eliminators of any kind allowed on ACT Late Model approved cars.

17. SHOCKS

BRANDS APPROVED ARE KONI / QA1 AND MUST BE RUN AT ALL ACT EVENTS.

KONI SHOCKS

KONI Model #:

KON30-7436	KON30-9325
KON30-7499	KON30-9436
KON30-7325	
KON30-7647	

1. No KONI approved 9" shocks will be allowed on the front of cars. Approved KONI shocks are mandatory 7" on the front and 9" on the rear ONLY.
 2. A 7" shock at approved race ride height will maintain a maximum compression of within 3.5 inches (there will be a reasonable variance not to exceed .5 inches at the sole discretion of the technical inspector).
 3. A 9" shock at approved race ride height will maintain a maximum of 4.5 inches (there will be a reasonable variance not to exceed 1 inch which will be at the sole discretion of the technical inspector).
- Shock bump stops enclosed with KONI package will **NOT** be allowed for use on ACT approved KONI shocks. **Absolutely no removing of the plastic cap on the end of shock barrel.**

QA1 SHOCKS

QA1 Model #:

6375-400	6394
6375-500	6394-6
6375-650	6395-3
6375-850	

1. No QA1 approved 9" shocks will be allowed on the front of cars. Approved QA1 shocks are mandatory 7" on the front and 9" on the rear ONLY.
 2. A 7" shock at approved race ride height will maintain a maximum compression of within 3.5 inches (there will be a reasonable variance not to exceed .5 inches at the sole discretion of the technical inspector).
 3. A 9" shock at approved race ride height will maintain a maximum of 4.5 inches (there will be a reasonable variance not to exceed 1" which will be at the sole discretion of the technical inspector).
- ALL measurements for KONI / QA1 will be done with driver in driver's seat.
 - Only KONI / QA1 part numbers listed are approved for ACT Late Model competition.
 - NO changing or altering KONI / QA1 shock in anyway.
 - KONI / QA1 shocks MUST NOT be painted, and model numbers must be fully legible.
 - KONI / QA1 brand shocks can be mixed and matched on car.
 - Shocks may be swapped at any time with ACT inventory by ACT Tech Inspectors.

18. SWAY BAR

- A. Aftermarket one solid bar side to side only. MUST be mounted on bottom side of front clip & work off the lower A-frames. NO rear sway bars allowed.
- B. Sway bars must be mounted parallel with front cross member and will be measured from rear of

engine with 1" tolerance.

Maximum sway bar diameter 1.75"

19. BRAKES and HUBS

A. Any safety or racing type hubs allowed made of steel, aluminum, or magnesium and of same offset right and left. 5x5 or wide 5 bolt patterns allowed. Front brake rotors must be a minimum of 1 inch thick and made of steel. Rear brake rotors must be minimum 3/4 inch and made of steel.

B. Brakes (all four) must be single piston calipers made of steel and must be GM D154 type or D52 type replacement calipers only, all four brakes must be in good working order.

Master cylinders and pedals of any type allowed.

NO turn style piston calipers or spring-loaded piston calipers allowed – NO internal pressure adjustments allowed in calipers.

C. Brake duct allowed, no blower. Ultra Cool Brake Fans are allowed, steel or aluminum. You MUST maintain tread width.

20. REAR ENDS

A.

1. Rear ends must have floating type bearing and hub such as quick change or "non-quick" change, front load quick change, or steel housing-type 9" floater with steel center section gear carriers only allowed.
2. No cambered rear ends or rear ends with yaw (dog tracking), or offset or shimmed snouts allowed.
3. No crowned axles.
4. All rear ends must be driven with solid drive flange plates.
5. NO TITANIUM PARTS ALLOWED.
6. All running gear drainage plugs must be safety wired.
7. No rear axle tube tow in or out allowed.
8. Minimum outside diameter of rear axle shafts allowed is 1.050 absolute.

B.

- Rear ends **must have spool ONLY**. At select events, a rear end gear rule will be in effect and posted in entry forms.
- No gold tracks or any type of ratchet or limited slip.
- Drive shafts must be made of steel and must be painted white.

C.

- Truck arm or three-point type rear mounting allowed.
- Rear trailing arms may use rubber bushings and heim joints.
- No spring rods.
- **Only one rubber snubber in any of the three point trailing arms or third link, your choice which one. Maximum three rubber biscuits per snubber, no springs.**

D. Solid tubular pannard bar only. One bar, two adjustable heim joints only.

E. No aluminum truck arms, no fifth coils, no Watts linkage, no torque arms, no mechanical devices to transfer weight while car is in motion allowed.

21. COOLING SYSTEMS

1. Any radiator allowed overflow must blow on right lower quarter of windshield.
2. ACT-approved spec motors may run electric fans.
3. Stock cast water pump or aluminum pumps allowed. Oil coolers allowed.
4. NO antifreeze will be allowed.

22. TRANSMISSIONS/CLUTCHES

- A. 1. Transmissions must be stock **GM** standard 3-speed.
- The early Muncie and later Saginaw three-speed stock transmission are the only GM transmissions approved for competition, with the following exceptions:
 - a.) REM polishing allowed.
 - b.) No rollarized gear on main shaft allowed.
 - c.) No other altering of transmissions will be allowed without written approval by ACT.
2. No automatics allowed.
 3. Steel type bell housing mandatory for conventional clutch use.
 4. No carbon fiber materials will be allowed in clutch assembly.
 5. Mandatory bell housing must remain 360⁰ and shall not be altered, except for inspection hole not to exceed 2" in diameter to be drilled in bottom of bell housing.
 6. Aluminum bell housing will be allowed with disc clutch and ACT crate motor.
 7. Shifter may be any type – single or two rod.
- B. Disc clutch assembly that will be the ACT Late Model approved clutch:
Quarter Master Part #: 298103ZZ – 7.25 2 disc-V-drive / Tilton Part #: 56-4206
(2Disc Clutch 10 spline LMC w/Neutral Button)
- Quarter Master Part #: 298308 / Tilton Part #: 56-4506**
(2Disc Clutch 10 spline with Ford Button)
- GM flex plate: 14088765 ONLY**

23. STARTERS

- A. Reverse mount starters allowed **only on Ford engines**. Starters must remain in stock location.

24. TIRES and WHEELS

- A. ACT approved 8-inch tire only. ACT tire rule is in effect for all ACT events.
- B. Specified tire mandatory on all four wheels. Tires are available at track. Tires must be on an 8" rim mandatory. Front wheels must maintain same offset left and right 64.5" tread width. Rear wheels must maintain same offset left and right 64.5" tread width. Must be aftermarket racing type wheels made of steel. Wheel spacers may be used and **must be one-piece wheel spacer MANDATORY – on wide 5 hubs. Maximum ½" thick spacer per wheel**. Lightening of wheels of any kind not allowed – must be stock out of box.

ALL MEASUREMENTS ARE OFFICIAL WITH ACT GUAGES.

OFFICIAL MEASUREMENT IS 72 1/2" - MEASURED FROM OUTSIDE TO OUTSIDE OF RIMS, WITH DRIVER IN CAR.

- C. Chemical treating of tires **WILL NOT BE** allowed. No shaving of any tires allowed in the ACT Late Model division.
- D. Tire clean up with scraper blades allowed. No steel brushing or any form of liquid allowed to clean tires.
- E. Questionable tires, or tires not meeting above criteria as determined by officials, may be

confiscated by officials and could result in disqualification, and/or other penalties.

- F. LM Tour events require use of specified tire **ONLY**.

25. **Safety Requirements**

- A. Fire retardant driver's suit highly recommended. Fire retardant gloves **MANDATORY**.
- B. All cars must have safety cutoff switch on driver's right-side crossbar. Must be within reach of driver and accessible to safety crews from both left and right side.
- C. Aluminum racing seat mandatory **or carbon fiber seat allowed with SFI safety rating of 45.1**. Driver's seat must appear as close to stock position as possible and must be securely fastened (bolted, not tack welded), to rollcage and frame members and not to floorboards.
- D. Quick release aviation-type minimum 3" safety belts required. Shoulder harness required to be fastened to rollcage, not in gussets. **Cam-lock type allowed. Shoulder harnesses must be NO less than 2" wide "IF" passing over head and neck restraint system.**
- E. An approved driver's window screen mandatory. Requires seat belt type latch. Must be attached at top and bottom front by single seat belt locking device and 3/8" steel rod top and bottom, **or spring lock type allowed.**
- F. Rollbars must be padded in driver's area. Center of steering wheel must be padded.
- G. **It is mandatory that a 2-1/2 lb. fire extinguisher with gauge be attached to the car interior, on driver's right-side crossbar. Must be within reach of the driver and accessible to safety crews from both left and right side. Extinguisher must be mounted in quick release bracket only, no taping. On board fire system highly recommended.**
- H. Two drive shaft loops to fully enclose drive shafts mandatory, no less than 1" wide and 1/8" thick must be placed around drive shaft front and rear attached to the floor or cross member.
- I. The following are suggested to aid in your safety: goggles, fire retardant socks and undergarments, DOT or SNELL approved automobile racing helmets.

26. **MISCELLANEOUS**

- A. Contact ACT office for licensing information as numbers will be issued to license holders only and will be assigned upon receipt of license application by the ACT office. All ACT competitors will carry state or provincial identity, which will be assigned through the ACT licensing process. No metallic numbers. Numbers remain in effect only for season issued. **Numbers on roof shall be readable from front stretch tower position for Race Control.**
- B. All cars must have a permanent mounting bracket for their Westhold transponder. Refer to the diagram and information on page 19 for bracket location.**
- C. All illegal parts must be surrendered at time of inspection to ACT official or will receive at least a two-week suspension and/or minimum \$50.00 fine. This includes questionable tires.
- D. Race procedures, inspections, and safety regulations will be governed by officials of ACT in the best interest of the sport. Officials of ACT retain the right to revise the above rules as they deem necessary. These rules and procedures will be adhered to EIRI.
- E. Radios will be allowed for the Late Model division. *One spotter per car is required in designated area for feature event.*
The following is MANDATORY
1. A minimum of (2) two-way radios are required per car with communication between the driver and a crew member.

2. All teams must have 1 scanner programmed to receive the ACT race control frequency (454.000) and must always have a crew member monitoring this channel during every ACT event. This crew member must be able to communicate directions to the driver via the two -way radios referred to above #26 D-1.

- F. Spotters required to have car # visible on both right and left headset ear cuff, and back of headset.
- G. No traction control devices will be allowed.
- H. ***Competitors wishing to participate in purse payouts and/or point fund must run decals as required by ACT.***
- I. ***Owners point fund payments will be paid on 100% participation by owner.***
- J. ***Championship titles will be determined by driver's assigned points.***
- K. **NO ANTIFREEZE – if found in violation you will be fined.**

27. ELIGIBILITY

- A. Drivers must purchase Late Model driver license and must present proof of issuance of license. Only licensed members may be allowed in pits at reduced fee.
- B. Rookie Eligibility:
 - 1. Driver must file Rookie Registration information with ACT Office.
 - 2. A driver's rookie season is defined as the first season when they qualify for more than three feature events in a single season.
- C. ***Driver must attend a minimum of 80% of point-counting events to be recognized as Rookie of the Year candidate.***

NOTE: Failure to attend 80% of point-counting events does NOT mean that a driver retains their Rookie Eligibility in subsequent seasons.

28. ACT TESTING POLICY

- ACT race teams will not be allowed to test at a racetrack 7 days prior to a scheduled or re-scheduled sanctioned event taking place.
- Teams will be allowed to test prior to the opening of season (exception: 7-day rule at opening venue).
- After first race of season, teams may test up to a maximum of four sessions at any track at any time, except within 7 days of scheduled/re-scheduled event.
- Teams participating (attempting to qualify for event) in a weekly or special event are exempt from testing rule.
- Scheduled practice days associated with ACT-sanctioned event are waived from this policy.
- Amendments and special circumstances that alter this rule require the approval of the ACT Office.
- Violators of the testing policy may receive fines, point and/or other disciplinary or handicap penalties.

IT IS THE RESPONSIBILITY OF THE COMPETITOR TO OBTAIN AND BECOME FAMILIAR WITH THE CURRENT RULES PERTAINING TO THE DIVISION IN WHICH HE/SHE CHOOSES TO PARTICIPATE. ANY ITEM NOT COVERED IN THE ACT RULES SECTION MUST BE STOCK OR APPROVED IN WRITING BY ACT OFFICE. IF ANY ITEM BEING CONSIDERED BY COMPETITOR IN THIS DIVISION IS NOT ADDRESSED IN THESE RULES, COMPETITOR IS REQUIRED TO CONTACT ACT FOR A JUDGEMENT AS TO ACCEPTABILITY.

The rules and/or regulations set forth herein are designed to provide for the orderly conduct of racing events and to establish minimum acceptable requirements for such events. These rules shall govern the condition of all events, and by participating in these events all participants are deemed to have obtained, read, and understood a copy of the current rules, and complied with these rules. **NO EXPRESS OR IMPLIED WARRANTY OF SAFETY SHALL RESULT FROM PUBLICATION OF OR COMPLIANCE WITH THESE RULES AND/OR REGULATIONS.** They are intended as a guide for the conduct of the sport and are in no way a guarantee against injury or death to a participant, spectator, or official.

All rules are subject to change in the interest of competition.

Rules **EIRI 111824**



Website: www.acttour.com

Administrative Office

Telephone: 802-244-6963

E-Mail: media@acttour.com

For Technical questions:

Pete Knights - ACT Tour – Telephone: (802) 673-8408

Email: knights7177@gmail.com

Call between the hours of 6pm – 9pm

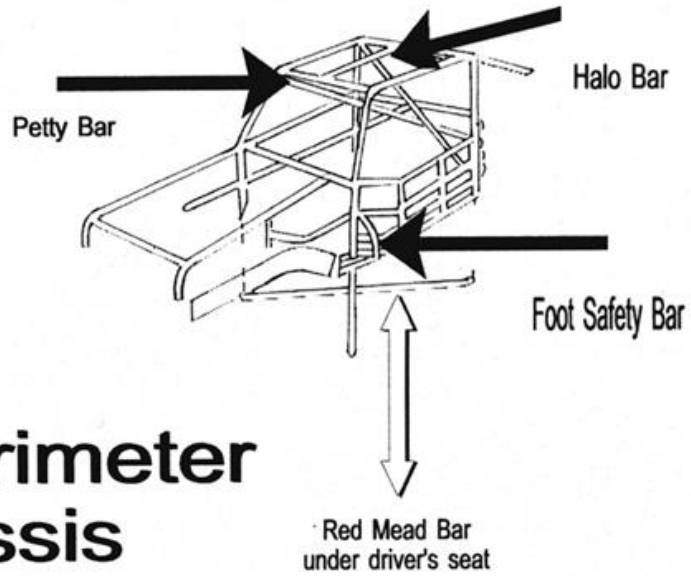

Full Perimeter Chassis

Typical Front View

Frame reinforcement recommended for existing cars.
 Frame reinforcement REQUIRED for new cars.

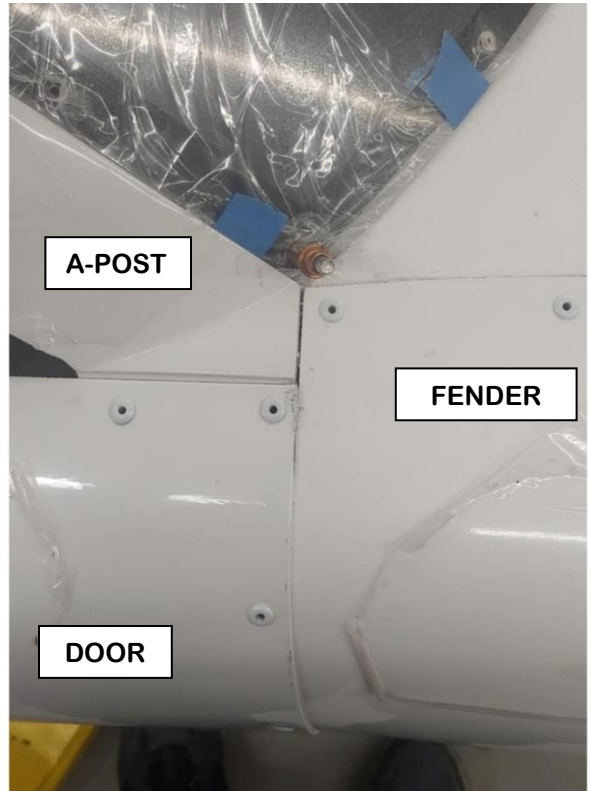
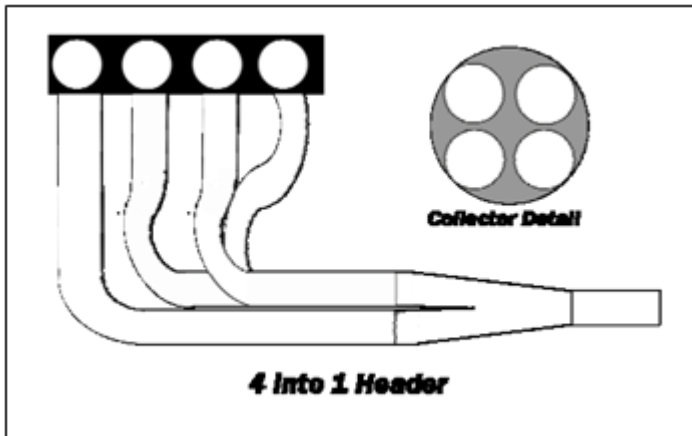
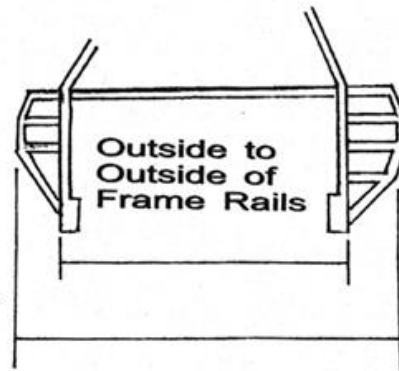

ABC Body Dimension Sheet

ABC BODY DIMENSIONS

- A NOSE FLAP HEIGHT: 13"
- B FRONT OVERHANG (MAX): 46"
on centerline
- C SIDE WINDOW OPENING (MIN): 15"
at B-post
- D REAR WINDOW LENGTH: on centerline**
Five Star bodies 31½"
AR bodies 31½"
- E NOSE/SIDE PANEL CLEARANCE (MIN): 4"
from ground
- F BUMPER COVER HEIGHT (MAX): 15"
from ground
- G REAR OVERHANG (MAX): 47"
from base of spoiler at centerline to axle centerline
- H ROOF HEIGHT (MIN): 47"
10" back from windshield, on centerline
- I FENDER HEIGHT: 32½"
at rear
- J DOOR HEIGHT (MIN): 33"
at rear
- K QUARTER PANEL HEIGHT: 34½"
at bumper cover/deck lid intersection (+/-½")
- L WINDSHIELD ANGLE: 26/50°
at center/at roof windshield post
- M REAR DECK LENGTH (MAX): 23¼"
at center, from base of spoiler to rear window**
Five Star bodies 23¼"
AR bodies 23¼"
- N FRONT OF ROOF TO CENTER OF REAR AXLE: 57½"
- O QUARTER PANEL HEIGHT: 13"
at back of wheel well opening
- P BUMPER COVER HEIGHT: 347/8"
at base of spoiler, on centerline
- Q BODY WIDTH (MAX): 79½"
at wheel wells
- R DOOR TO DOOR WIDTH (measured through car): 68"
at A-posts and inside edges of doors
- S DOOR TO DOOR WIDTH (measured through car): 67"
at B-posts and inside edges of doors
- U ROOF HEIGHT, REAR: 45½"
at centerline
- V RIGHT DOOR TOP: 3½"
to center of roll
- W LEFT DOOR TOP: 2½"
to center of roll

* If Dimensions H, I, J, K or P are higher than the stated dimensions, all five must increase by the same amount.
 ** Must fit centerline template within allowable tolerance.
 *** 13 inches is the height of the nose flap only. This dimension is not measured from the ground.

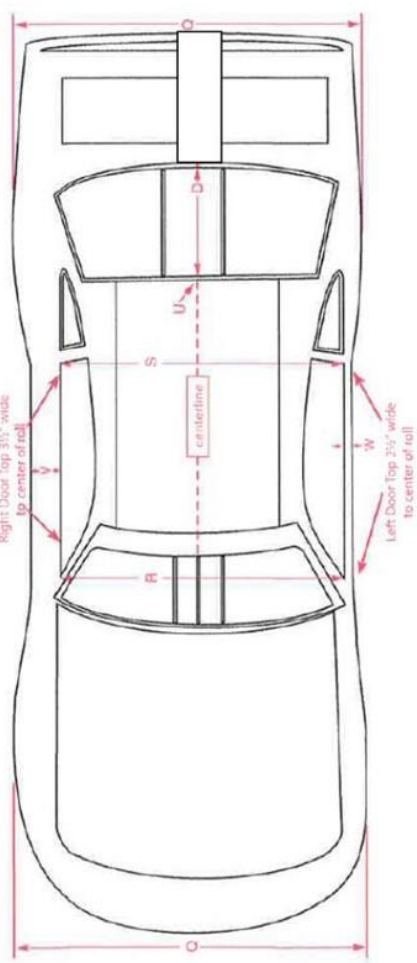
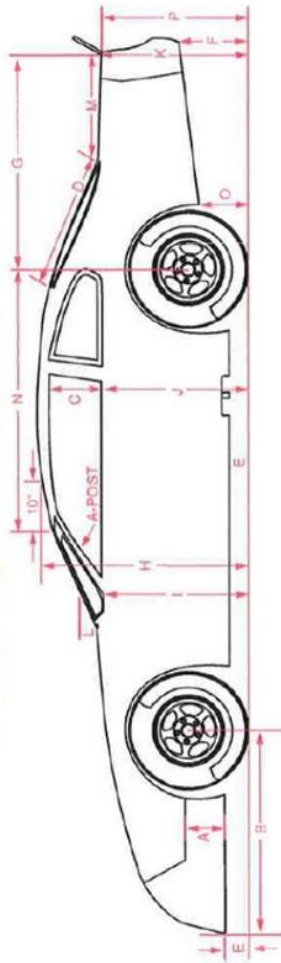

Official ABC-approved Label Locations

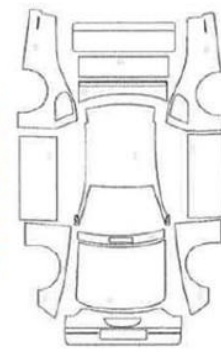

Bumper Cover Location

See photo BC-1 on page 16 for full text.

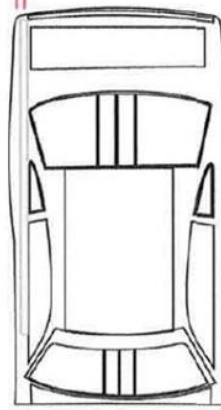

Maximum allowable distance that the right edge of spoiler can extend beyond the inner edge of the straight edge will be 1/2".



NEW LATE MODEL BODY DIMENSION GUIDELINE CHART

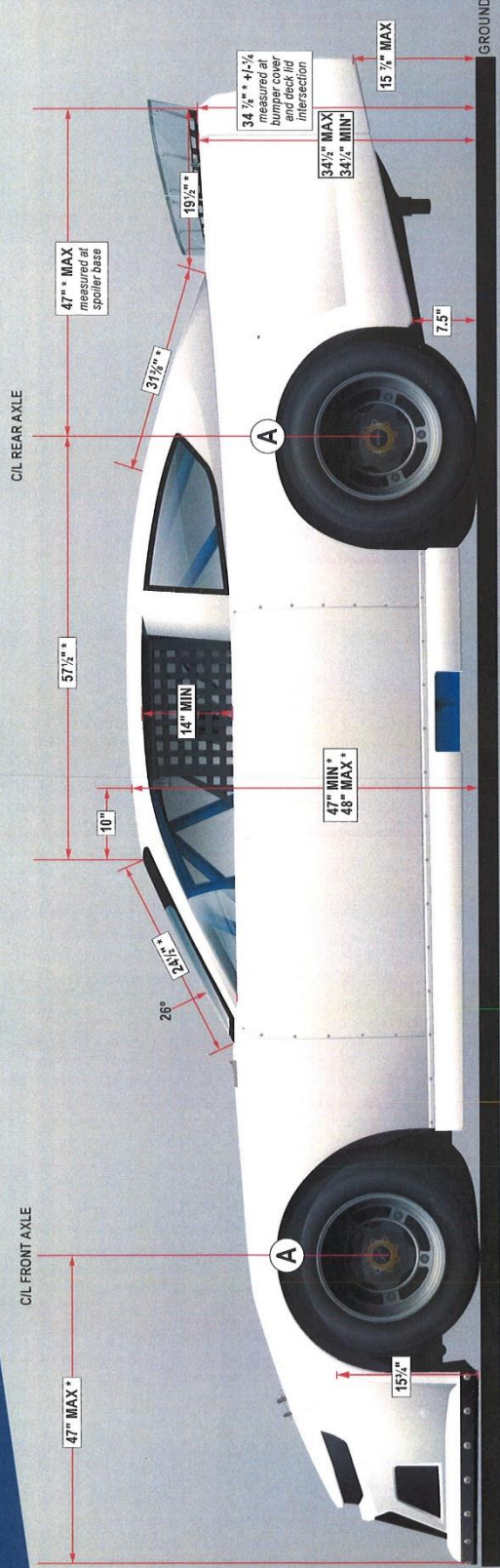

AERO CRITICAL AREAS

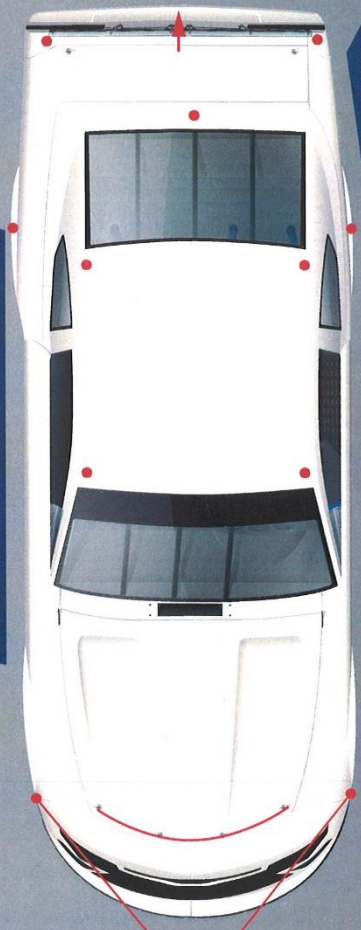

ROOF HEIGHT
47"

A 79 1/2" MAX
BODY WIDTH:
Measured at wheel wells

NOTES:
1. If the Roof Height (10" back from windshield), Fender Height (rear), Door Height (rear), Quarter Panel and Bumper Cover Height dimensions are higher than the stated dimensions, all five must increase by the same amount.
2. Must fit centerline template within allowable tolerance.
* Measured at the centerline.

2020 Super Late Model Revolution Series Body Dimension Guideline

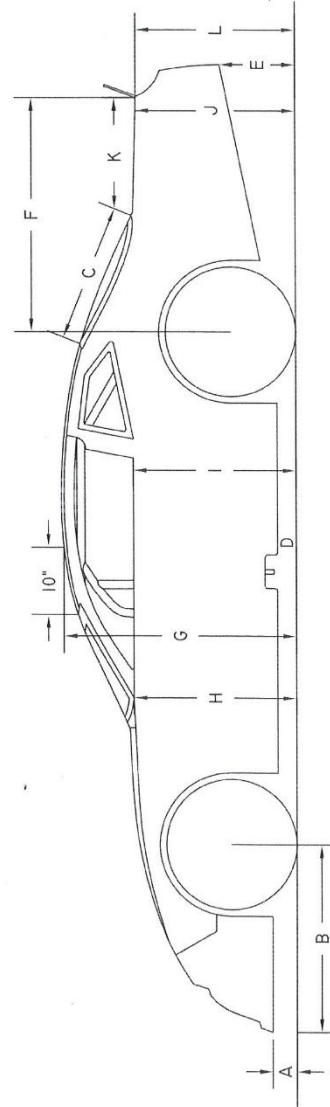
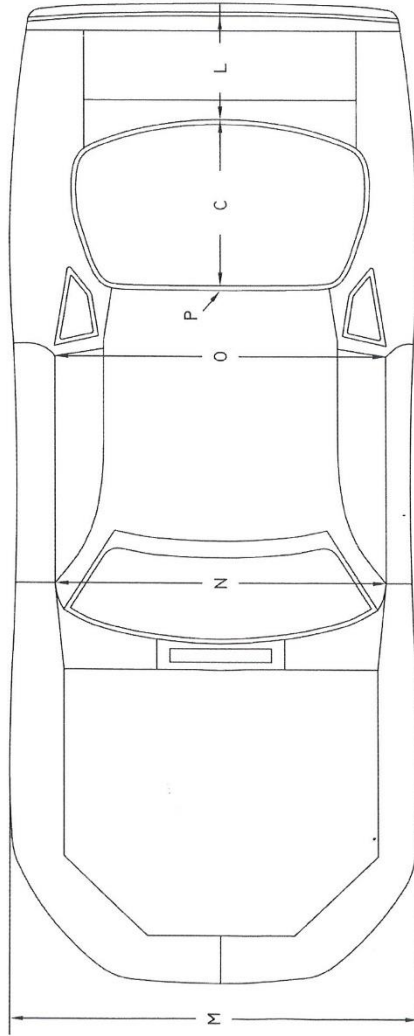

A.	NOSE HEIGHT (MIN): from ground to bottom of nose	4"
B.	FRONT OVERHANG (MAX): on centerline	48"
C.	REAR WINDOW LENGTH: on centerline	31 1/4"
D.	SIDE PANEL CLEARANCE (MIN): from ground	4
E.	BUMPER COVER HEIGHT (MAX): from ground	16"
F.	REAR OVERHANG (MAX): from base of spoiler at centerline to axle center	47"
G.	ROOF HEIGHT (MIN): 10" back from windshield, on centerline	47"
H.	FENDER HEIGHT: at rear	33" MAX
I.	DOOR HEIGHT: at rear	33"
J.	QUARTER PANEL HEIGHT: at bumper cover/rideclid intersection (34 1/4" MIN)	34 1/2"
K.	REAR DECK: at center, from base of spoiler to rear window	23 1/4"
L.	BUMPER COVER HEIGHT: at center	34 7/8"
M.	BODY WIDTH (MAX): at wheel wells	79"
N.	DOOR TO DOOR WIDTH (measured through car): at "A" post and inside edges of the doors	67"
O.	DOOR TO DOOR WIDTH (measured through car): at "B" post and inside edges of the doors	66"
P.	ROOF HEIGHT, REAR: at centerline	45 1/2"

2308 Industrial Drive P.O. Box 540 Greenbrier, TN 37073 1-888-245-1468

ACT uses the Westhold transponder system. If you currently use a Westhold transponder you will be allowed to use yours in our event. If you do not you will be issued a rental transponder on the day of the event.



Late Model Transponder Mounting Locations

The transponder must be mounted in compliance with the diagrams provided below. It must be mounted on a bracket inside frame rails. The center of the transponder must be **six (6) inches** back from the rear edge of the rear end tube (see diagram #1). Also, the bottom most part of the transponder should not be below the bottom most part of frame. Transponder must be mounted in a direct horizontal plane (see diagram #2) to the ground with label side down and lights point towards the front or rear of the car. The clearance from the racetrack to the bottom of the transponder should be as close to a maximum of twelve (12) inches as possible.

DIAGRAM #1

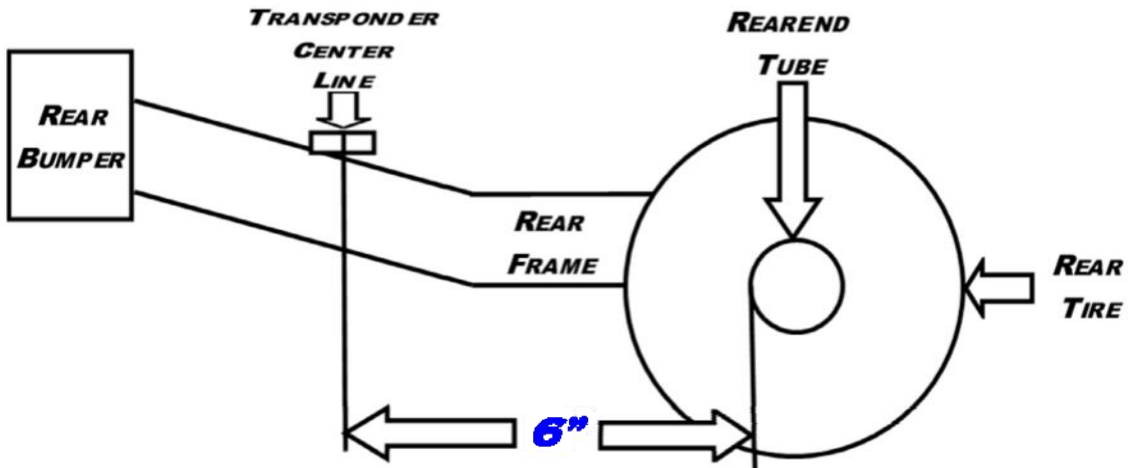
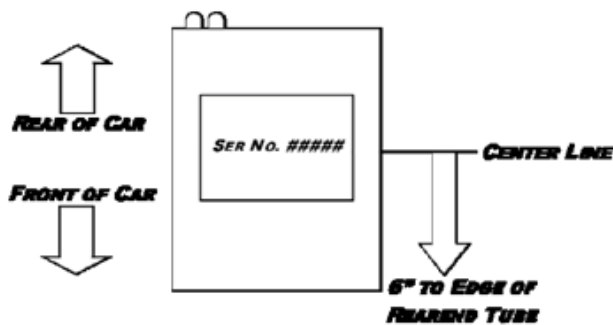

DIAGRAM #2

VIEW OF TRANSPONDER AS SEEN FROM TRACK SURFACE



NOTE: Permanent Hardwired Transponders are available for purchase and are mounted in the same orientation and position as the rentals. **Rental transponders must be returned after each event.** To purchase a transponder contact Westhold – www.westhold.com or (408) 533-0050.

Crate Engine Owner _____

Team # _____

Driver _____

Division _____

ACT 2025 ACT LATE MODEL CRATE MOTOR REGISTRATION ACT

ALL COMPETITORS USING A CRATE ENGINE TO COMPETE IN ANY ACT EVENT

MUST COMPLETE THE FOLLOWING AGREEMENT:



Engine Serial Number – (stamped on block, passenger side in front of head)

Crate Engine #1 _____ **Seal #** _____ **Seal #** _____ **Seal #** _____

Crate Engine #2 _____ **Seal #** _____ **Seal #** _____ **Seal#** _____

Engine Builder _____

By registering and signing this agreement, you will be allowed to compete and receive prize money and points at ACT-sanctioned events. There will be NO prize money or points issued without registering spec engine with the ACT Office prior to competing.

AGREEMENT:

1. I agree to the policies regarding the ACT Late Model Crate engine program, as outlined in the ACT rules and regulations, procedural manual, this registration, or any other requirements which might be established.
2. I understand that the ACT Crate Engines are not to be tampered with. Any unauthorized breaking of the seals or unauthorized freshening or altering in any way is a violation of the ACT rules.
3. I understand that by registering my crate engine(s) and using it/them to compete in any ACT-sanctioned event, I, or my assigned driver(s), are subject to any and all penalties which might be imposed from time to time by the ACT organization.
4. I agree to abide by the ACT policy that a crate motor may be confiscated for inspection at any time. If the integrity of the said motor is not fully in compliance with the ACT rules and regulations, I further understand that I am subject to penalties which may be imposed by ACT, and my privilege to compete may be forfeited.
5. Failure to comply with the demand of the ACT Official in Charge to confiscate crate motor for inspection purposes will result in suspension of all privileges for competitor(s) of sealed motor(s) to compete at any ACT events for up to one year. Other penalties may be issued. Team will be responsible to place motor in truck or trailer of ACT choice for transport to builder inspection facility. Cost of inspection and delivery will be borne by ACT if found legal, and all costs will be the responsibility of competitor if found illegal.

I understand and agree to the terms and conditions as outlined above.

Crate Engine Owner

Crate Engine Driver

Witness

Witness

Date

Date